

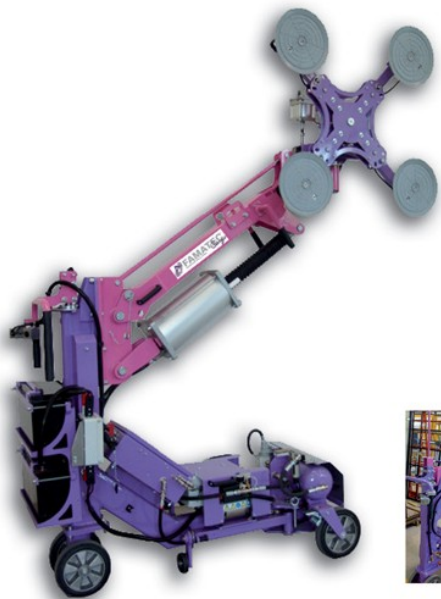

FAMATEC[®]
HANDLING SOLUTIONS
Gingo



250 kg

350 kg

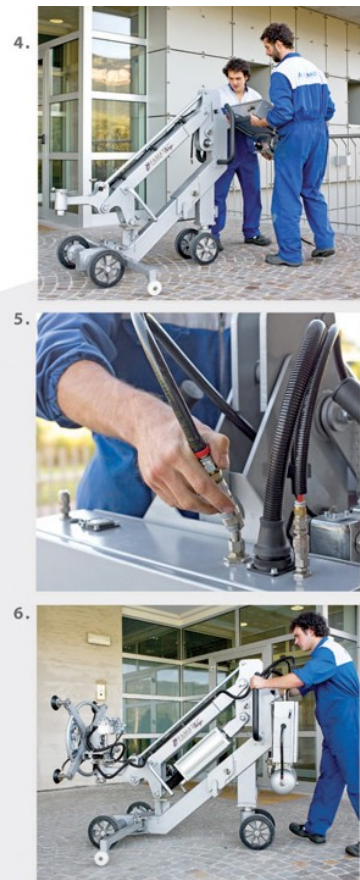
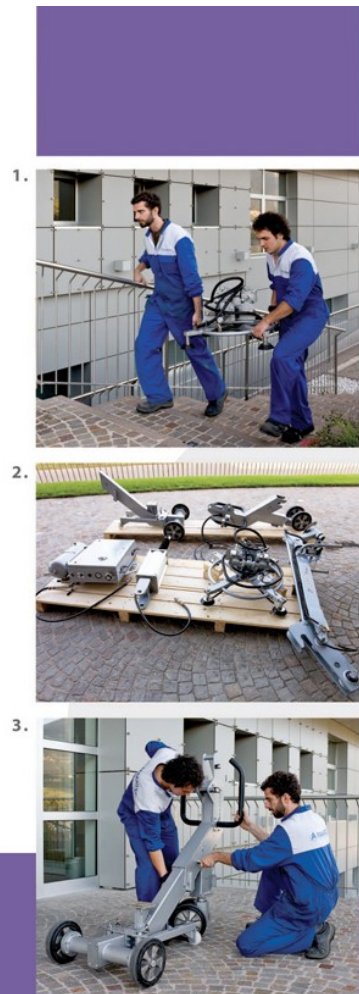

Gingo can be dismantled in six pieces easily carried by hand and re-assembled in only three minutes.

1. Balanced vertical movement



2. Frontal inclination $\pm 10^\circ$



3. Axial rotation 180°

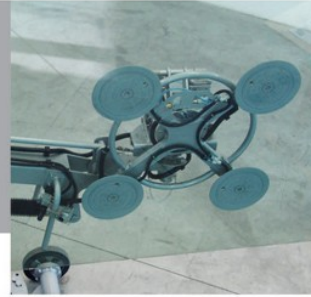

4. Frontal rotation 180°

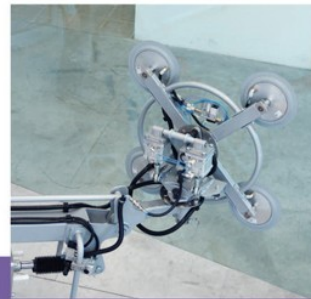
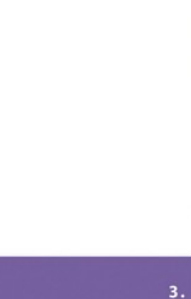
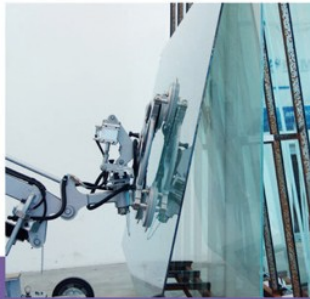
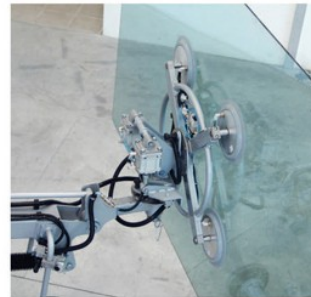
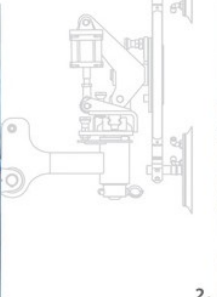
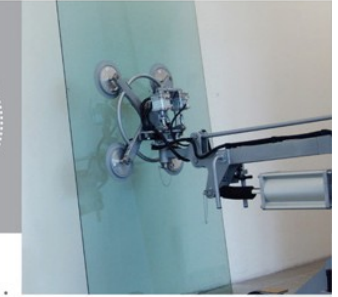

4. Frontal rotation 180°



1.



5. Side movement 160 mm

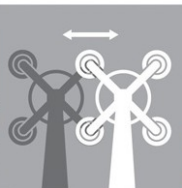

1.



Accumulation tank to ▶
guarantee full cycle in
case of air failure

FAMATEC
HANDLING SOLUTIONS *Gingo*

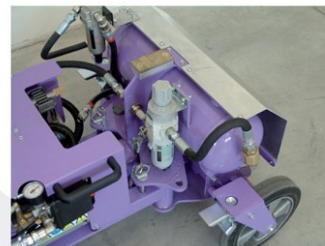

A min mm	A max mm	Bmm	Cmm	D min mm	D max mm	E mm	L min mm	L max mm
780	2.200	800	1.365	280	540	678	1.850	2.100

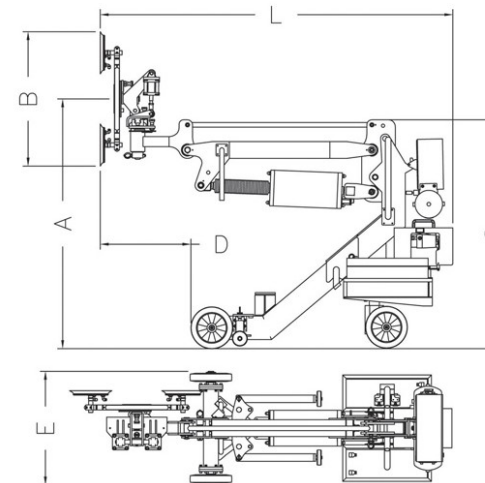

2.

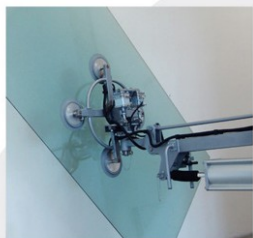

2.

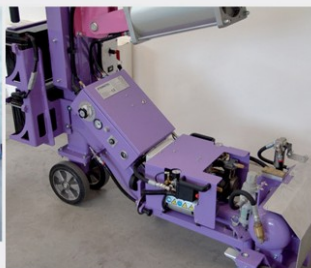
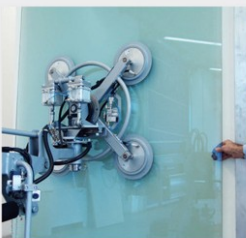

"FREE" option: 24V battery
kit with double compressor
and battery charge included



3.



3.

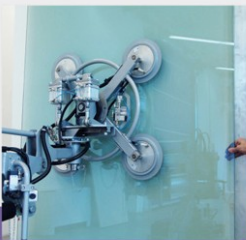

Gingo



Balanced movement that allows the positioning of the glass/sheet directly by **hand**.



W> www.famatec.com

@> sales@famatec.com



They have already chosen Famatec:

3 ELLE / AGC / ALBERTINI / CASCADE WINDOWS / CHAMPION WINDOWS & DOORS / CRICURSA
 CRISTALERIA SOLER / CUSTOM WINDOW SYSTEMS / DB GLASS / FINSTRAL
 ISOCLIMA / M&C / MIROITERIES DUBRULLE / PERMASTEELISA / PILKINGTON / RIMADESIO / ROMAG
 SAINT GLAS LIMITED / SAINT GOBAIN / SANGALLI VETRO / SOMEK / TECHNOCLADD
 TRAINOR GLASS COMPANY / VELKO 2000 / VETRARIA COGLIATI / ZANATTA VETRO and many more...

Famatec S.p.a._ via dell'Industria 15 - 38012 TAO (TN) - ITALIA
 Tel_ 0039 0463 461911 Fax_ 0039 0463 461955

